

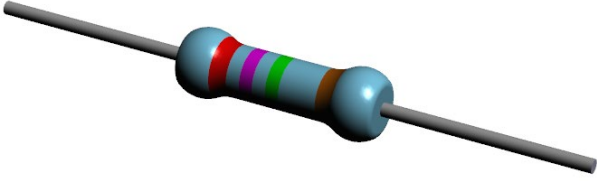

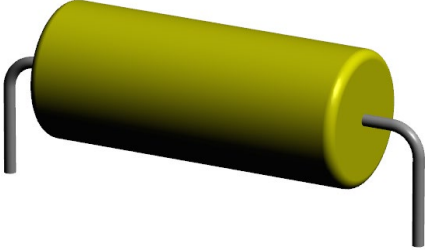
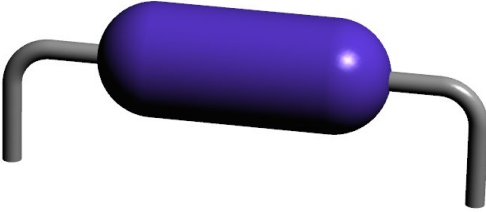

Non-polarized Axial Diameter Led Component

<p>Resistor (RESAD)</p> 	<p>Capacitor Non-polarized (CAPAD)</p> 
<p>Fuse Axial Diameter (FUSAD)</p> 	<p>Inductor Axial Diameter (INDAD)</p> 
<p>Non-polarized Axial Diameter Land Pattern Zero Rotation</p> 	

Polarized Axial Diameter Led Component

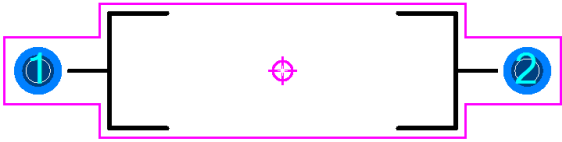
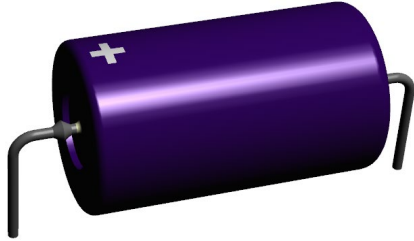
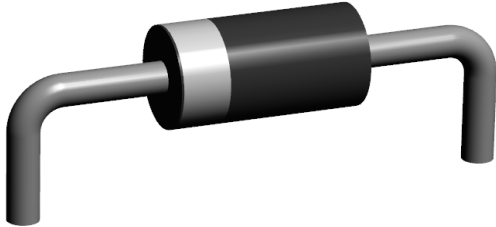
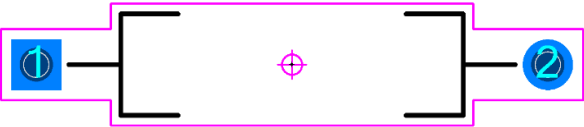
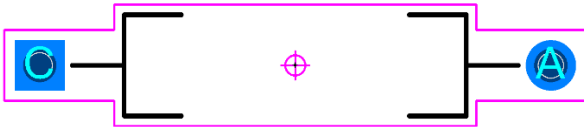

<p>Capacitor Polarized Axial Diameter (CAPPAD)</p> 	<p>Diode Axial Diameter (DIOAD)</p> 
<p>Capacitor Polarized Axial Diameter Land Pattern Zero Rotation</p> 	<p>Diode Axial Diameter Land Pattern Zero Rotation</p> 

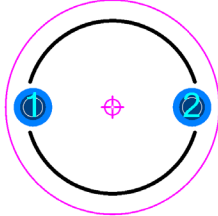
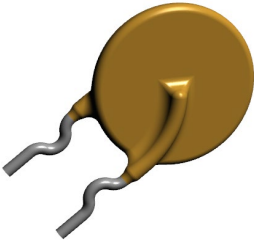
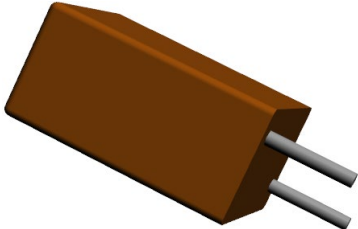
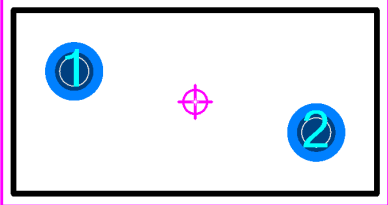
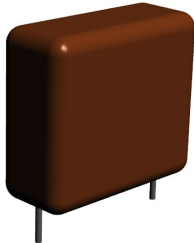
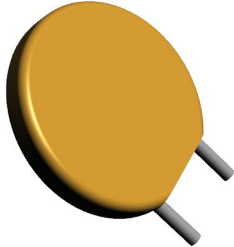
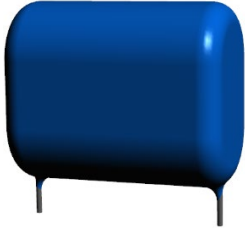
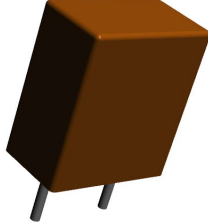
Non-polarized Radial Rectangular Ledged Component

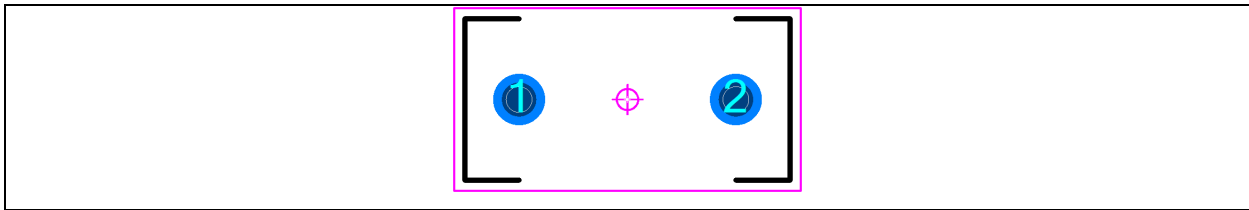
<p>Capacitor, Radial Dipped Diameter</p> 		<p>Capacitor, Radial Dipped Diameter Land Pattern Zero Rotation</p> 	
<p>Capacitor, Radial Disk Button w/Offset Leads</p> 	<p>Capacitor, Radial Dipped with Offset Leads</p> 	<p>Capacitors, with Offset Leads Land Pattern Zero Rotation</p> 	
<p>Capacitor, Radial Dipped Rectangle</p> 		<p>Capacitor Radial Disk Button</p> 	
<p>Capacitor, Radial Metallized Polypropylene</p> 		<p>Fuse, Radial Dipped Rectangle</p> 	
<p>Radial Capacitor and Fuse Land Pattern Zero Rotation</p>			

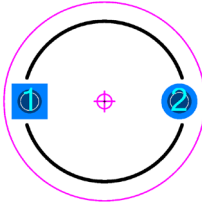
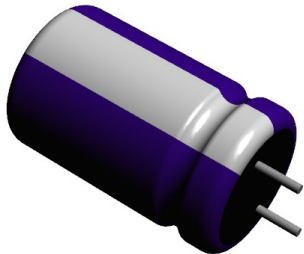
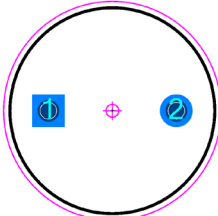
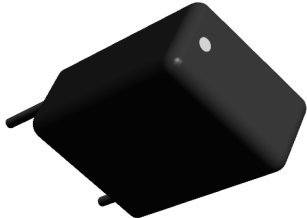
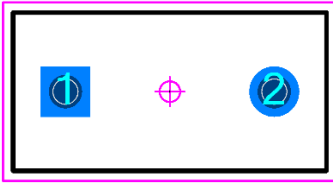
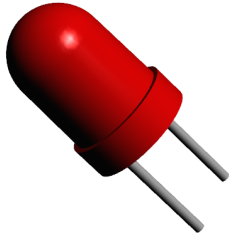

Polarized Radial Rectangular Ledged Component

<p>Capacitor, Polarized Radial Dipped Round</p> 	<p>Capacitor, Polarized Radial Dipped Round Land Pattern Zero Rotation</p> 
<p>Capacitor, Polarized Radial Electrolytic</p> 	<p>Capacitor, Polarized Radial Electrolytic Land Pattern Zero Rotation</p> 
<p>Capacitor, Polarized Radial Dipped Rectangle</p> 	<p>Capacitor Radial Dipped Rectangle Land Pattern Zero Rotation</p> 
<p>LED Radial Diameter</p> 	<p>LED Radial Diameter Land Pattern Zero Rotation</p> 
<p>LED Radial Rectangular</p>	<p>LED Radial Round Land Pattern Zero Rotation</p>

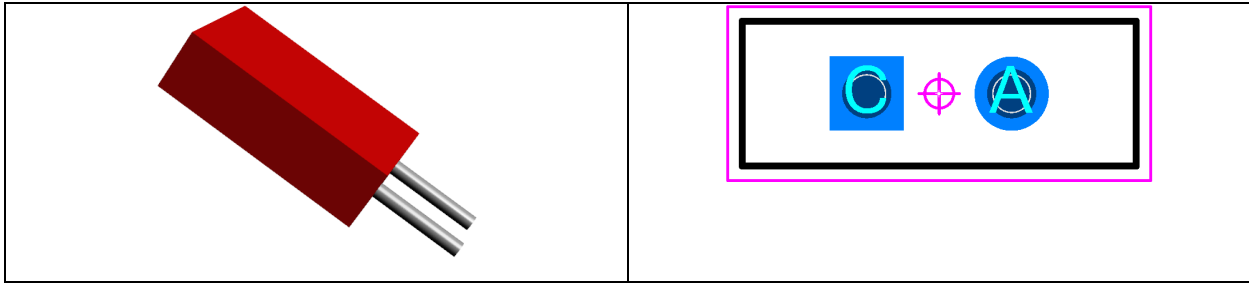

Two Pin Crystal (XTAL)

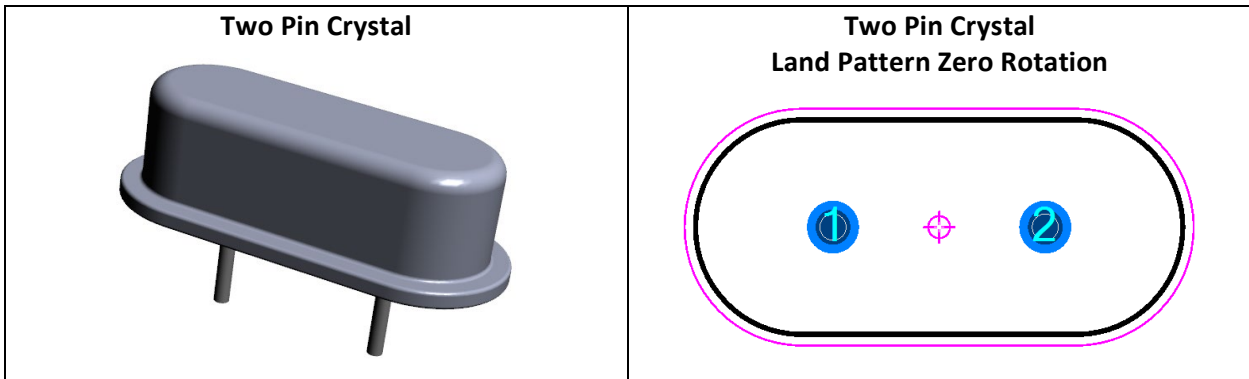

Four Pin Oscillator (OSC)

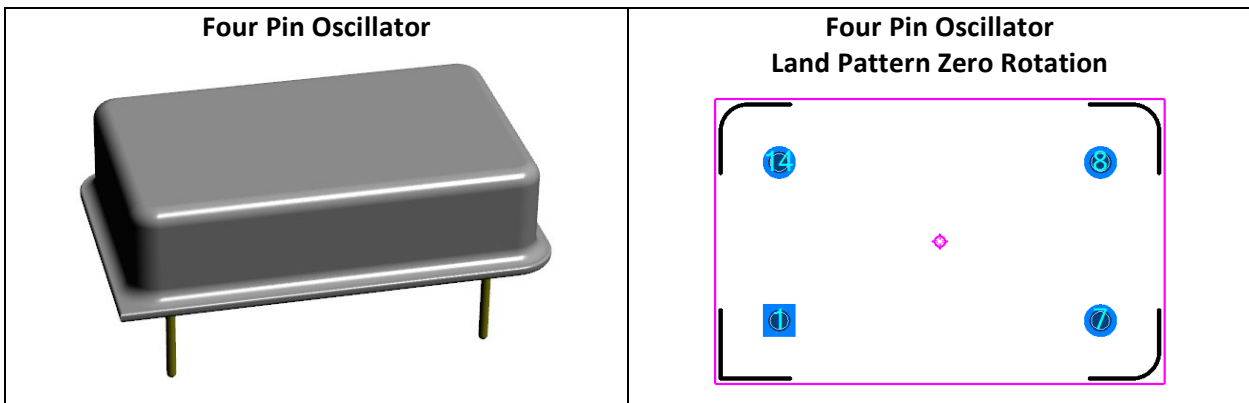

Flange Mount Horizontal (TO-220)

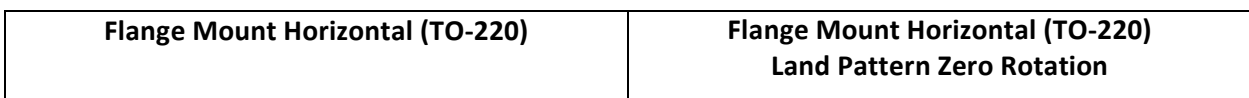

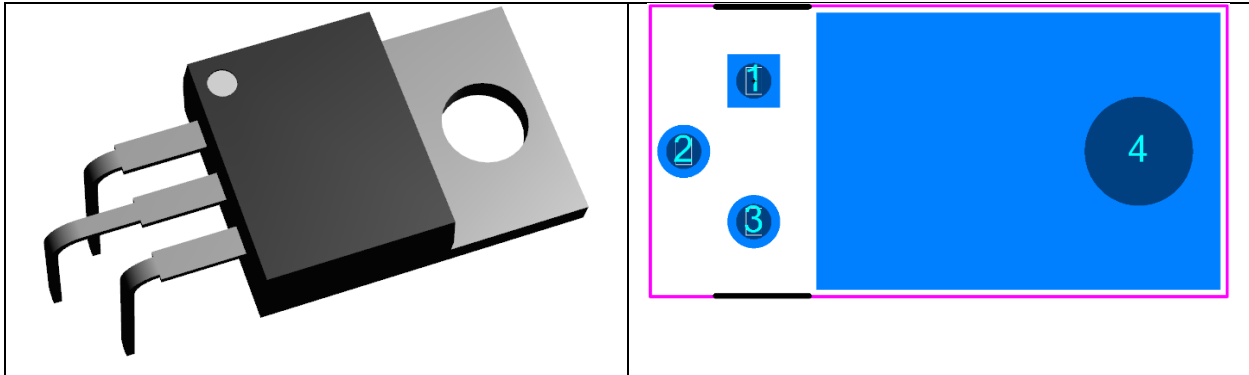

Flange Mount Vertical (TO-220)

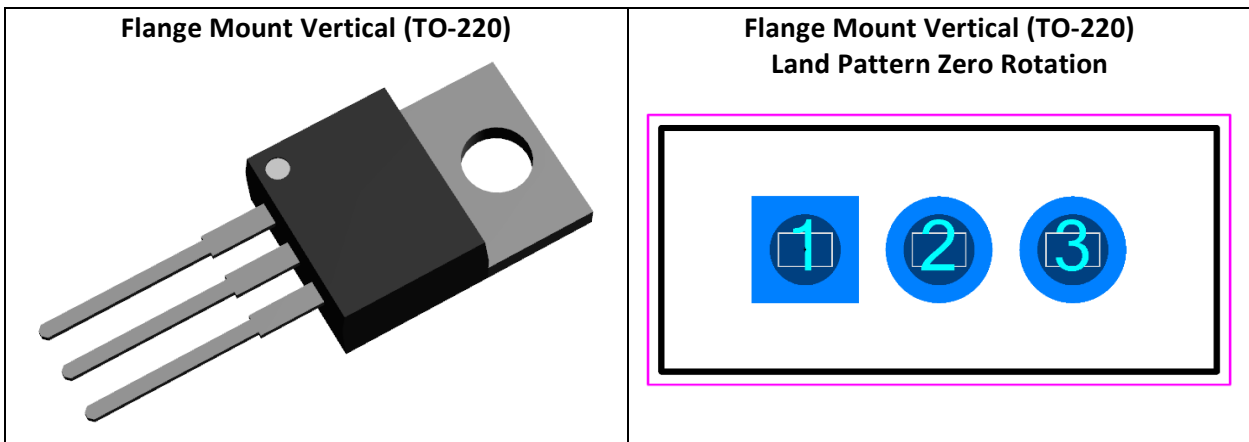

Cylindrical (JEDEC TO)

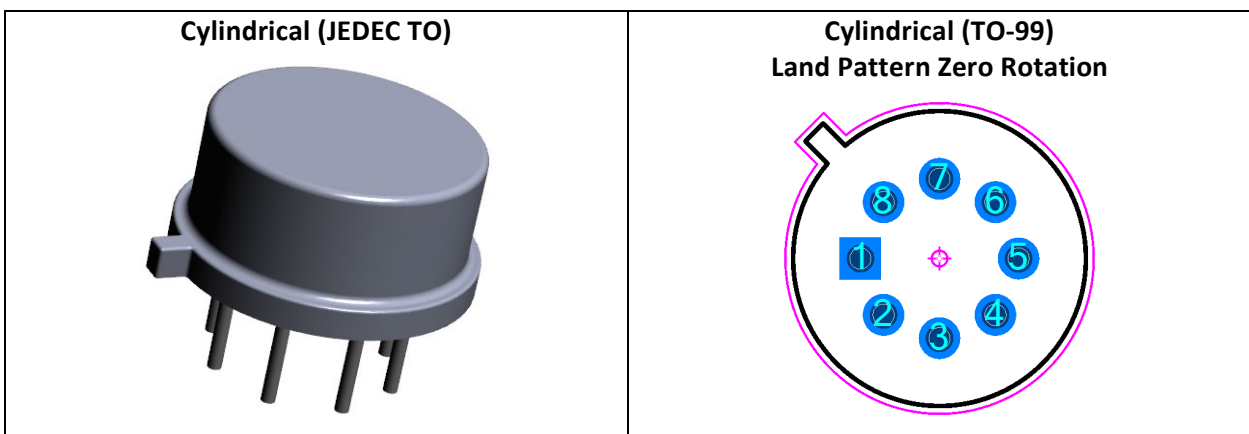

Single In-line Package (SIP)

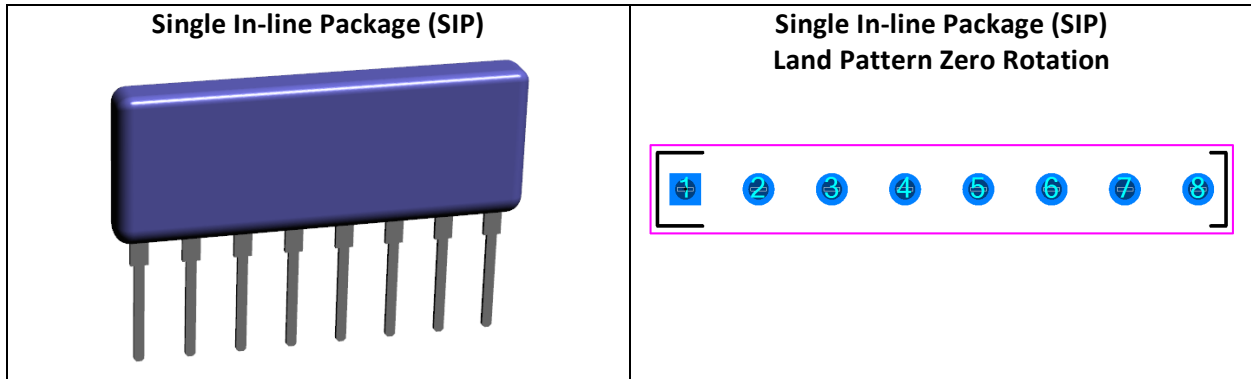

Dual In-Line Package (DIP)

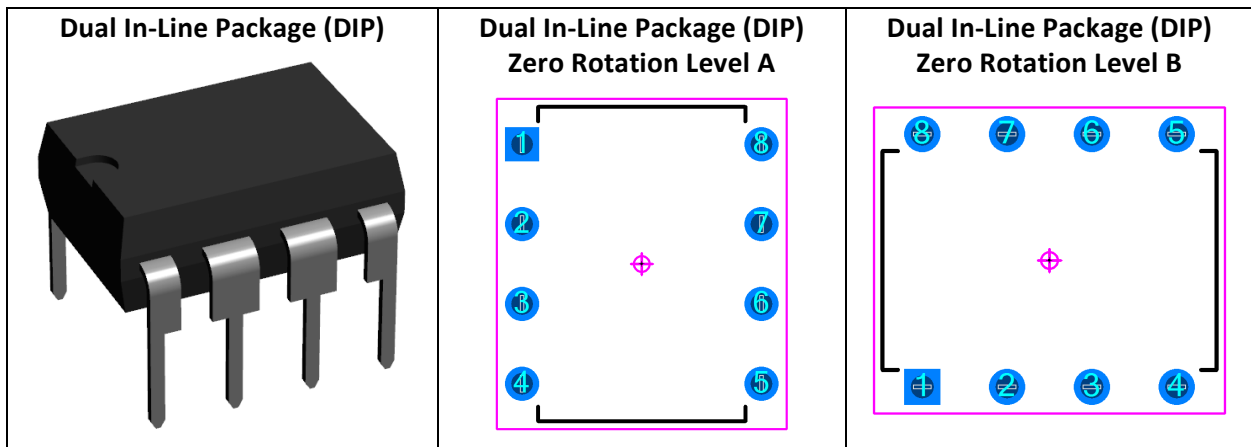

Dual In-Line Package Socket (DIPS)

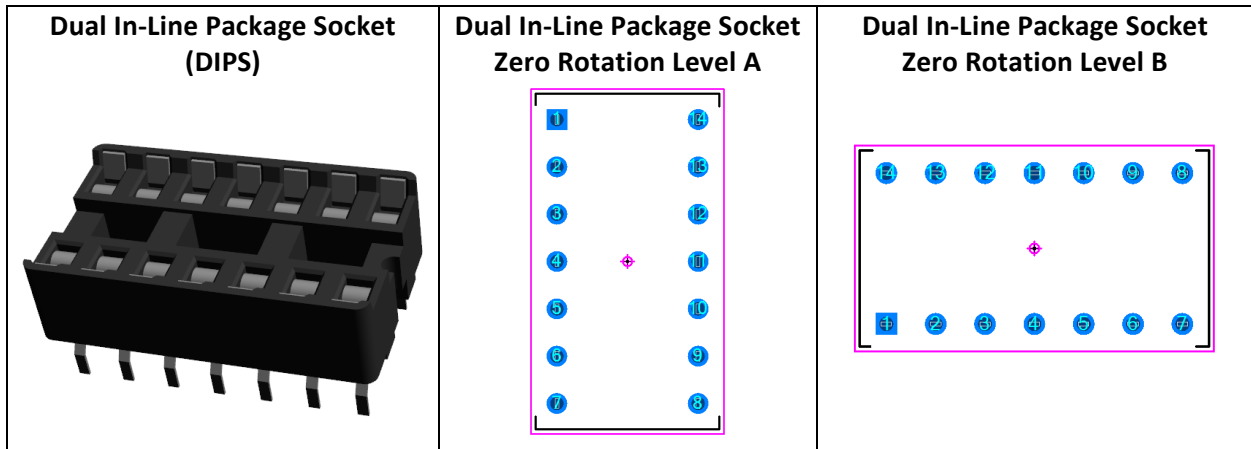

Header, Vertical (HDR)

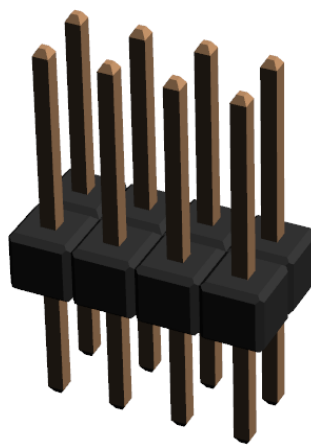
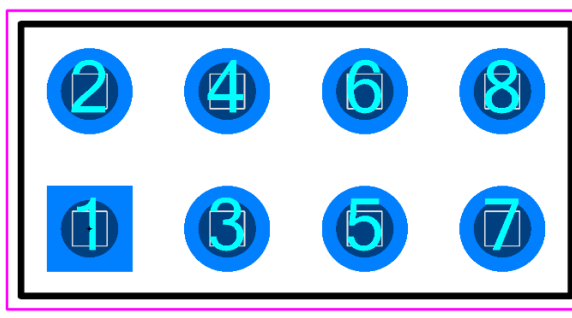
<p>Header, Vertical (HDR)</p> 	<p>Header, Vertical (HDR) Land Pattern Zero Rotation</p> 
--	--

Header, Right Angle (HDRRA)

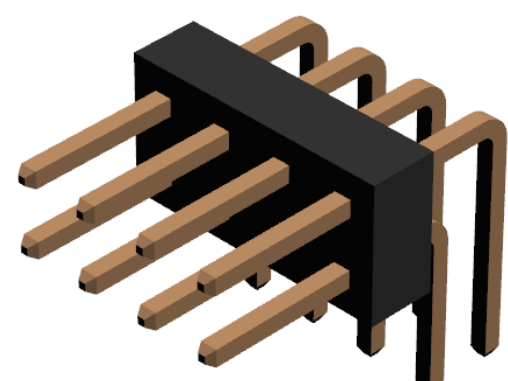
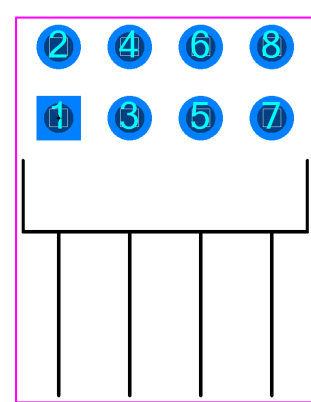
<p>Header, Right Angle (HDRRA)</p> 	<p>Header, Right Angle (HDRRA) Land Pattern Zero Rotation</p> 
--	--

Pin Grid Array (PGA)

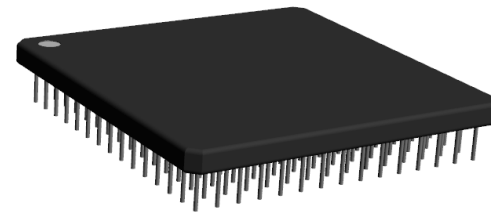
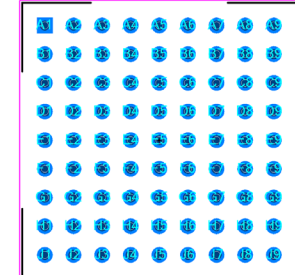
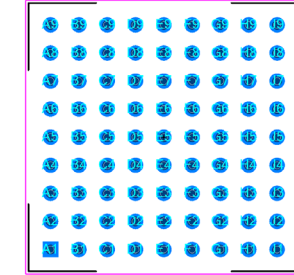
<p>Pin Grid Array (PGA)</p> 	<p>Pin Grid Array (PGA) Zero Rotation Level A</p> 	<p>Pin Grid Array (PGA) Zero Rotation Level B</p> 
--	---	--

Polarity Marking Legend

The goal of the Polarity Marking Legend is to aid assembly to avoid polarized component packages from being inverted during the assembly machine setup or manual solder process. Therefore, Polarity Marking is only necessary on land patterns that require a specific rotation during the assembly process. For very dense part placements, the polarity marker can be placed under the package and covered up during the assembly process. However, the best practice is to locate the polarity indicator outside the package so that it is visible after the assembly process to allow the end user to visually validate that the assembly insertion process is correct. This is typically known as “Post Assembly Inspection Process”.

Polarity Markings are unique from company to company. Here are samples of the most popular shapes.



The size, rotation and location of the Polarity Markings are user definable. Here are some recommendations.

The most popular polarity marking is a filled Dot. The size of the Polarity Marking is relevant to the size of the component package and pad width. However, the polarity dot size is also dependent on the part placement density and the assembly shops ability to easily locate the dot to avoid component rotation insertion errors. The smallest visible markings range from 0.25 mm – 0.40 mm and are typically used for micro-miniature packages or very dense part placement PCB layouts. The average size ranges are 0.50 mm – 0.80 mm. The largest recommended polarity dot is 1.00 mm.

This illustration indicates 3 popular locations for a 0.50 mm dot on an SOP package. The preferred polarity dot placement is at the end of the pad which is the furthest distance from the component package body. This makes the post assembly inspection process easy as the component package may move up or down during assembly reflow but the dot will always be visible. The acceptable location is the pad center but this location is also a potential via site. It is advisable to keep legend ink off non-tented vias or tented via holes. The not recommended location has a higher potential of a via site and the marking could collide with other parts during the part placement process.